

killerbody™

**LED Light System w/Control Box
(4 LEDS)
Used with R/C rally racing
Accent Light
NO.48099**

⚠ Not all the Radio Controller System compatible with this LED control box.
Due to limited wire length of the LED lights set, please pre-check proper fixture location before using 3M double-sided tape to fix it. We suggest to fix the LED lights set at the nearest area to the signal receiver which on the bottom of the chassis.

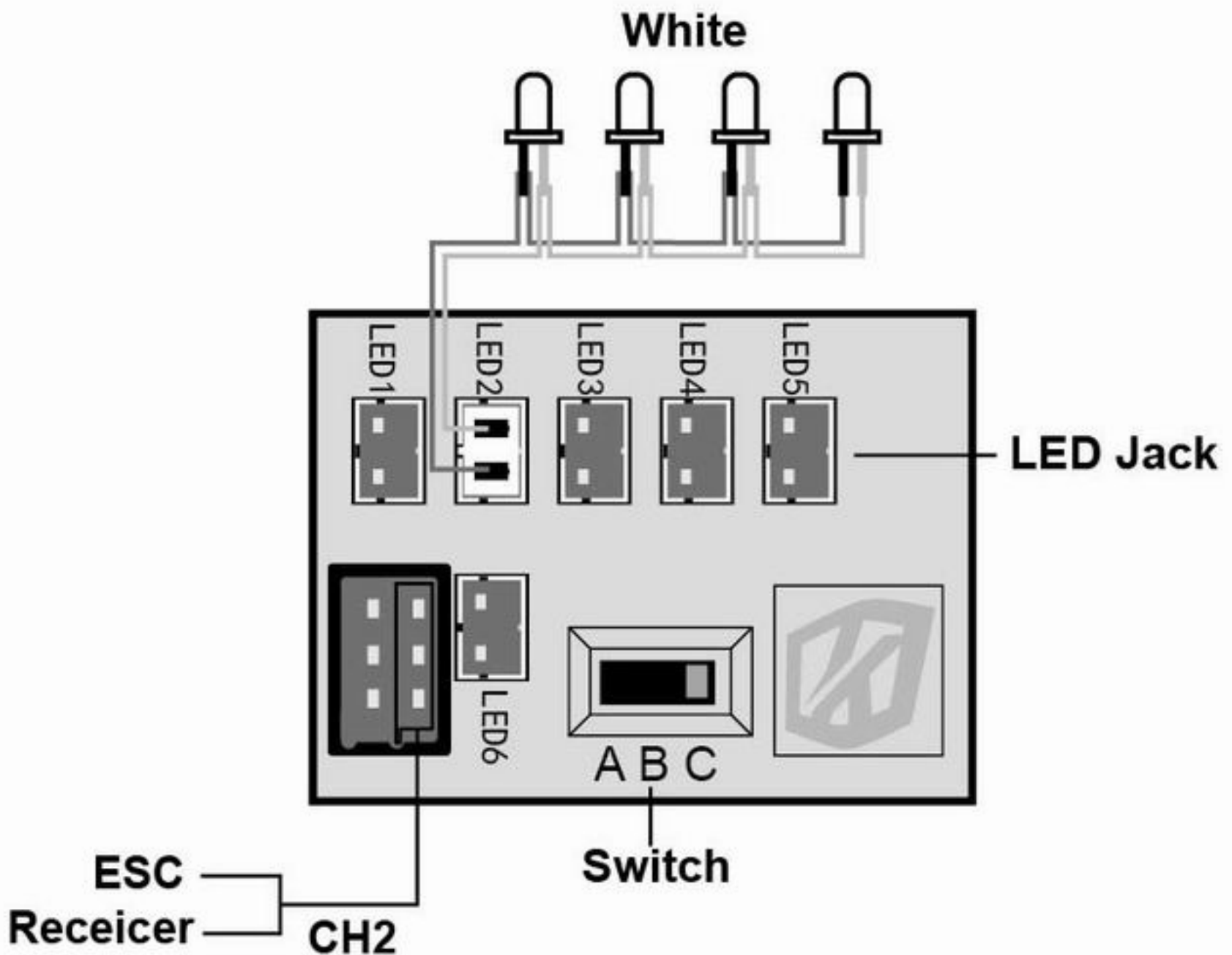

Port C

Function:

- 1) LED light (4 white lights) will flash when power connected.
- 2) LED light (4 white lights) will light up when received signal.
- 3) LED light (4 white lights) will light up dimly when stop control.